

# SIMULTANO PUNJENJE ELEKTRIČNIH VOZILA I OCJENJIVANJE SUPARHARMONIKA DO 150 KHZ U ELEKTRIČNIM VOZILIMA

## SIMULTANEOUS CHARGING OF ELECTRIC VEHICLES AND EVALUATION OF SUPRAHARMONICS UP TO 150 KHZ IN ELECTRIC VEHICLES

Jürgen Blum (JB), A. Eberle GmbH & Co. KG, Germany

### KRATAK SADRŽAJ

U sklopu opsežne kampanje za mjerenje, Tehničko sveučilište Bingen (THB) istraživalo je simultano punjenje deset punionica električnih vozila (EV) tijekom ljeta 2013. Glavni cilj bila je analiza struje punjenja i frekvencije uključivanja, kao i neravnoteže mreže zbog neravnomjerno raspoređenog tereta. Rezultati su pokazali da su se u nekim slučajevima dogodila kršenja standarda kvalitete električne energije. To ukazuje da će promatranje kvalitete električne energije u budućnosti postati sve važnije i da će se energetska elektronika punjenja morati dodatno poboljšati.

U drugoj kampanji za mjerenje u rujnu 2017. istražene su emisije do 150 kHz. Osim toga, istražena je uzajamna interferencija između različitih vozila i između električnih vozila i solarnih invertera.

**Ključne riječi:** kvaliteta energije, elektromobilnost, tehnologija punjenja, interakcija između električnih punjača i PV elektrana

### ABSTRACT

As part of an extensive measurement campaign, Technical University Bingen (THB) examined simultaneous charging of ten charging stations for electric vehicles (EVs) during summer 2013. The main objective was the analysis of charging current and switching frequencies as well as grid unbalances due to unevenly distributed loads. The evaluation showed that violations of power quality standards occurred in some cases. This indicates that the observation of power quality will become more and more important in the future and charging power electronics must be further improved.

In a second measurement campaign in September 2017 the emissions ranging up to 150 kHz have been investigated. In addition, the mutual interference between the different vehicles and between the electric vehicle and a solar inverter has been investigated.

**Key words:** power quality, electromobility, charging technology, interaction between electric vehicle chargers and PV power plants

Jürgen Blum, juergen.blum@a-eberle.de

### INTRODUCTION

The study »Power Quality in der Elektromobilität« from the year 2013 showed that more than 25 % of the examined EV's violate current harmonic thresholds during their charging process [1].

Today charging technology in electric vehicles has improved significantly, so exceedances of limit values have become much less frequent. The only connection condition that is still most often violated is asymmetry during single-phase charging of electric vehicles. In some cases, a single-phase charging power of up to 7 kW can be reached.

At mass-produced EV models, violations of power quality standards only occur if the charging electronics are faulty. The highest levels of harmonic currents appear at retrofitted electric vehicles with simple rectifier systems consisting of diodes with capacitive or inductive smoothing in DC circle.

The evaluation according to the VDN technical standard summarizes all relevant harmonic generators of a system with regard to the emissions to be expected at the common grid connection point. Both the individual harmonic currents and the totality of all harmonic currents are calculated using the distortion factor of the fundamental THD.

Power quality analyzers and fault recorders from A. Eberle in Nuremberg are used to measure the currents and voltages during charging. The sampling frequency of the PQ-Box 200 lies at 40.96 kHz, so that signal decomposition from DC to 20 kHz is possible. The measurement of supraharmonic voltages from 2 kHz to 170 kHz took place with PQ-Box 300.

**QUALITY OF CURRENT**

The circuit diagram of the charging station, where the measurement data for this paper has been captured is shown in Figure 1. The Charging points 1 to 8 are equipped with CEE sockets (32 A), of which the first four are brought together after approximately 30 meters. 63 A distributor plugs are connected to charging points 9 and 10 so that charging can be performed via Schuko, CEE or type 2 connections.

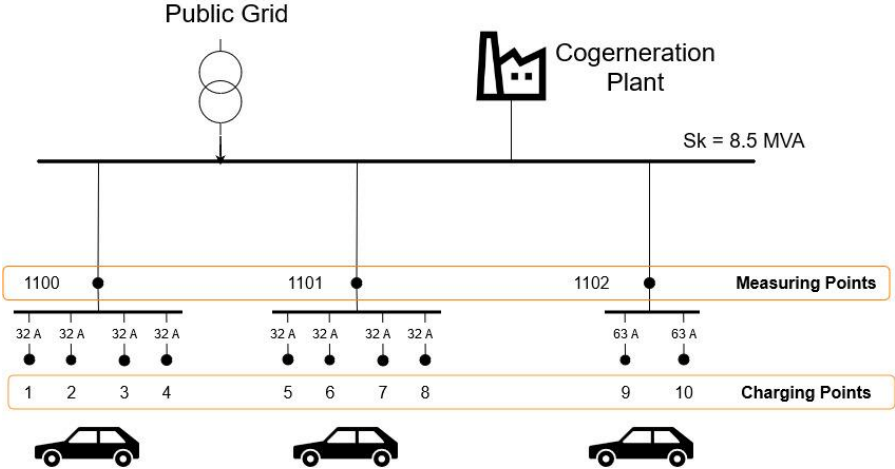

FIGURE 1: CIRCUIT DIAGRAM OF THE CHARGING STATION

All charging processes with the exception of two have complied with the limit values according to the D-A-CH-CZ guideline. This implies that all electric vehicles built as a series production and most converted electric vehicles show no limit value violations in the current flow. For charging the various electric vehicles, a charging station with a type 2 charging plug and various 32 A CEE outlets and single-phase outlets was available. The charging station was connected to the power grid of the University and uses a 25 mm<sup>2</sup> cable. The short-circuit performance at the charging stations is about 2.5 MVA.

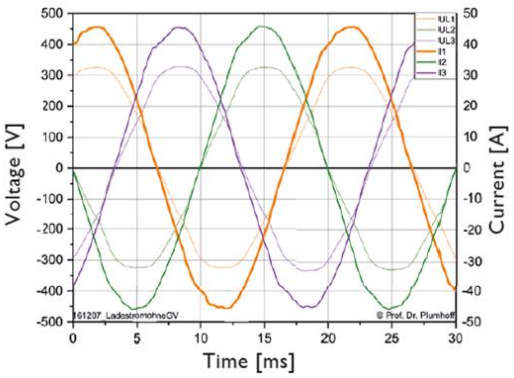

FIGURE 2: CHARGING CURRENT WITHOUT LIMIT VIOLATION

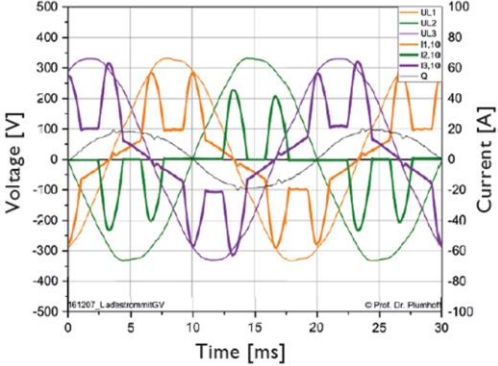

FIGURE 3: CHARGING WITH CAPACITIVE SMOOTHING

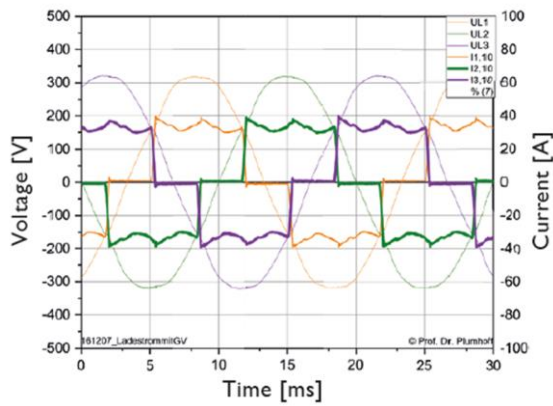

FIGURE 4: CHARGING WITH INDUCTIVE SMOOTHING

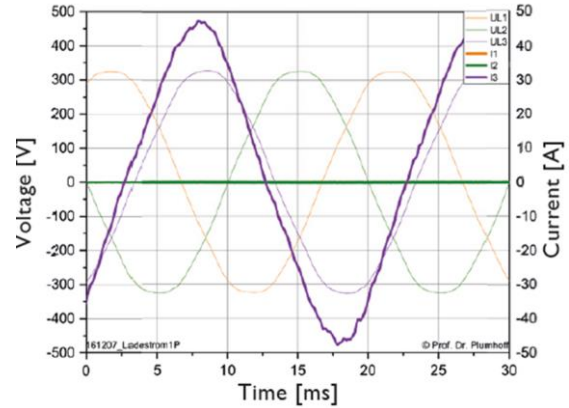

FIGURE 5: UNBALANCED CHARGING (7 kW, ONE PHASE)

Figures 2 to 5 show the different charging currents of electric vehicles. Norm-compliant as well as limit value-exceeding curves can be seen. In one case it is a simple capacitive smoothing, in the other case it is a simple inductive smoothing. Table 1 shows the evaluation of the two current curves exceeding the limit values. The first current signal with simple capacitive smoothing shows the expected high THD value of 118 %. The second current signal with simple inductive smoothing produces a THD value of 30 %.

TABLE 1: HARMONIC CURRENTS AND THDI - EVS WITH LIMIT VIOLATIONS

Harmonic	1. Capacitive equalisation		2. Inductive equalisation	
	DACH-CZ	Charging current	DACH-CZ	Charging current
H1		26,2 A		27,0 A
H3	3,0	2,1 A	2,0	0,4 A
H5	7,6	11,0 A	5,0	4,9 A
H7	5,0	8,7 A	3,3	5,0 A
H11	2,5	4,9 A	1,7	2,7 A
H13	2,0	3,0 A	1,3	2,5 A
H17	1,0	0,8 A	0,7	1,8 A
H19	0,8	1,1 A	0,5	1,5 A
H21	0,5	0,2 A	0,3	0,2 A
H23	0,5	0,8 A	0,3	1,2 A
H25	0,5	0,5 A	0,3	1,1 A
THD	31,6	118 %	20,8	30 %

During the measurement campaign, one EV showed up charging single-phase with approximately 7 kW (Figure 5). It is known that there are some power supply companies that have no problem with this kind of load but there are also suppliers who reject the connection of such an asymmetrical load (greater than 4.6 kVA).

Usually, the charging processes start with all phases involved. But there are also some series vehicles, which are designed in such a way, that one phase after the other is switched on (Figure 6).

At the very beginning of the charging process, the EV's charging current lies at 16 A and gradually increases to 32 A. Due to the strong asymmetry, the neutral conductor is temporarily exposed to the phase current and increases the neutral conductor-to-earth voltage. This leads to a slight increase in the voltage of the unloaded phases.

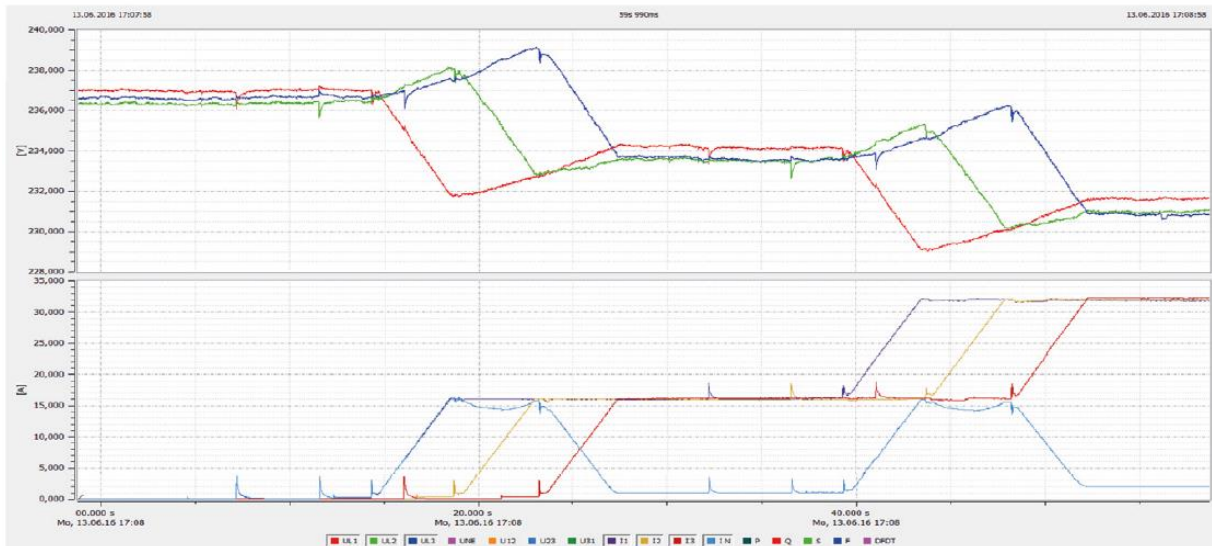

FIGURE 6: START-UP OF A CHARGING PROCESS - TIME SHIFTED PHASES

Among the 50 EVs to be charged this afternoon are two which showed faulty charging electronics (Figure 7). This leads to the question, whether the electronics itself should report such a fault or whether there should be a periodic error check.

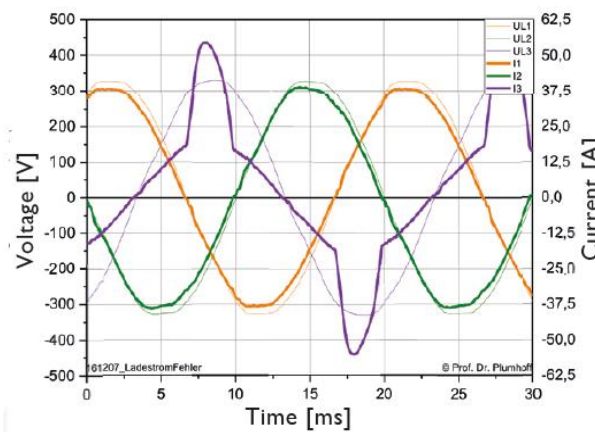

FIGURE 7: FAULTY CHARGING PROCESS

## HARMONICS OF CURRENT

The first four charging points (1 to 4) are brought together after approximately 30 meters in one connection (1100). So the currents of the measuring points 1 to 4 are recorded as a sum at measuring point 1100. At the time of the measurement, the current at measuring point 4 was equal to zero. The currents at the measuring points 1, 2, 3 and 1100 are shown in Figure 8 as harmonic spectrum. The arithmetic sum of the three currents is shown in red and the measured sum of the three currents is shown in black. The difference between these two currents leads to the conclusion that the harmonic currents of the different charging stations have different phase angles and thus partially extinguish each other.

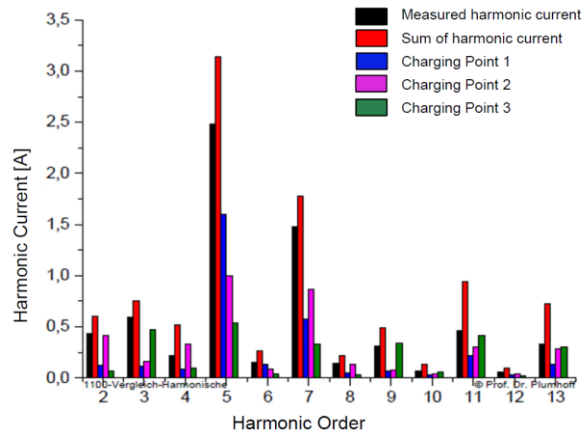

FIGURE 8: HARMONICS OF CURRENT AND THEIR ADDITION: 3 DIFFERENT E-MOBILES, LINEAR SUM AND MEASURED SUM

### SUPRAHARMONICS OF VOLTAGE

High switching frequencies are also emitted to the electrical grid by power electronics of EVs as can be seen in Figure 9 and Figure 10. In this regard, very clear differences showed up between the various manufacturers. The measurement of the emitted noise from the switching frequencies of the different manufacturers has been one of the main objectives of the measurement campaign. However, this investigation turned out to be problematic. Although each vehicle was connected to a separate supply line and CEE socket, all switching frequencies of the neighbouring vehicles showed up in voltage and current of the presently measured vehicle. This means that every vehicle and its power electronics represent an electromagnetic disturbance sink for supraharmonic frequencies and absorb these disturbance levels. As a result, it is not so simple anymore to determine the cause of these supraharmonic disturbances by analyzing the current spectrum at a measuring point. It has also appeared that vehicles may disturb each other to such an extent that the charging process is interrupted.

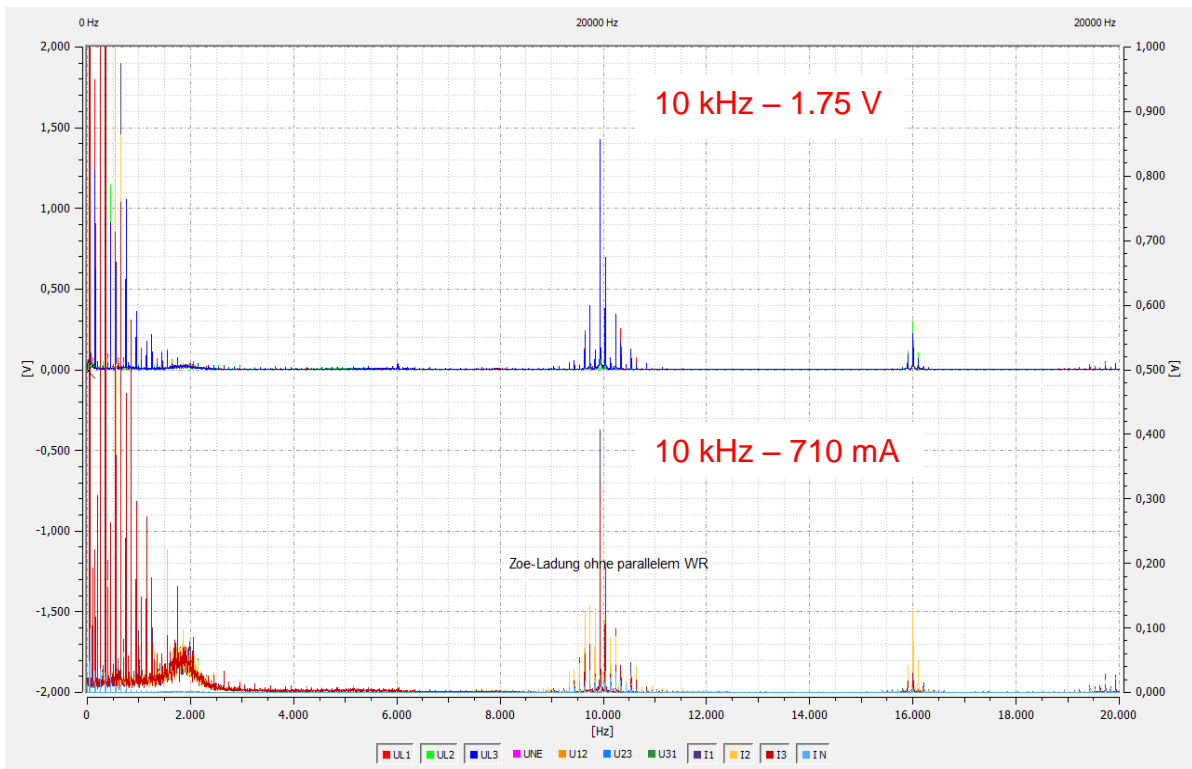

FIGURE 9: SPECTRAL ANALYSIS OF VOLTAGES AND CURRENT UP TO 20 KHZ, THIS CHARGER SHOWS A SWITCHING FREQUENCY OF 10 KHZ

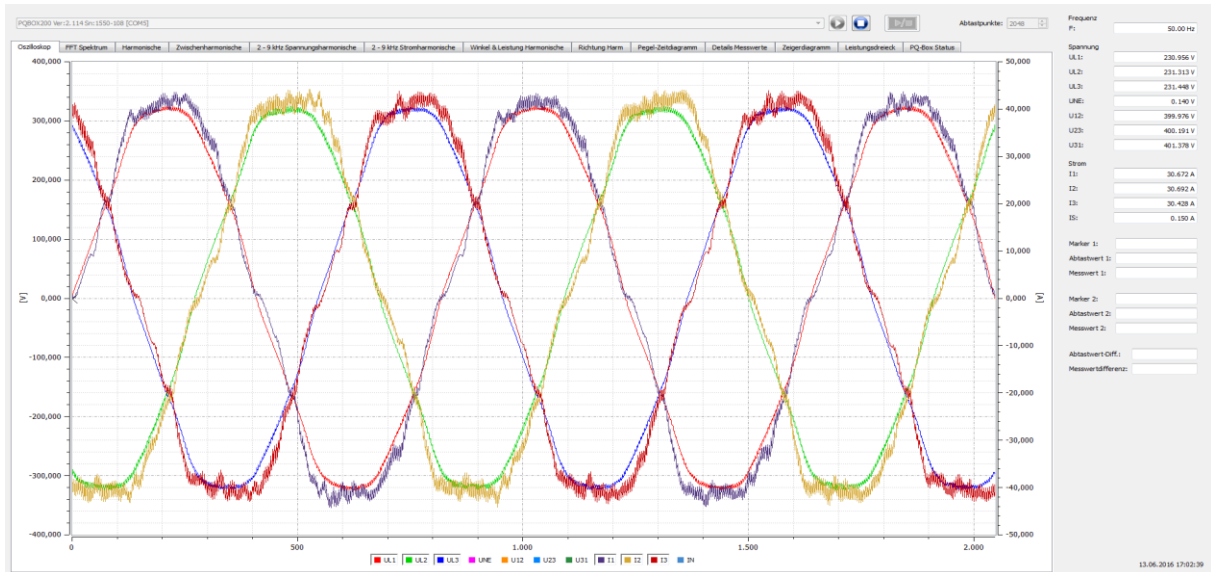

FIGURE 10: OSCILLOSCOPE PICTURE OF VOLTAGE AND CURRENT, SWITCHING FREQUENCY IS CLEARLY VISIBLE

### BASICS OF THE EVALUATION OF CHARGING EFFECTS

The IEC 61851-21-1 standard (Electric vehicle on-board charger EMC requirements for conductive connection to AC/DC supply) will apply to electric vehicles in the future. This standard has already received the status of FDIS and will be published shortly.

At this time, the limits for current harmonics as given by IEC 61000-3-2 (Class A) up to 16 A and IEC 61000-3-12 (asymmetrical devices,  $R_{sc} = 33$ ) for 16 A up to 75 A apply to electric vehicles. These same compatibility levels are also used in IEC 61851-21-1. There are limits up to the 40th current harmonic (2 kHz) and compatibility levels from 150 kHz to 30 MHz.

Since 2018 the compatibility levels of the frequency range between 2 kHz and 150 kHz are defined in IEC 61000-2-2 [5] for the following ranges:

TABLE 2: COMPATIBILITY LEVELS ACCORDING TO IEC 61000-2-2 (2018)

Frequency range	Compatibility level
2 kHz to 3 kHz	1.4 %
3 kHz to 9 kHz	1.4 % to 0.65 % Logarithmic drop-off with logarithmically increasing frequency
9 kHz to 30 kHz	129 dB( $\mu$ V) to 122 dB( $\mu$ V)
30 kHz to 50 kHz	122 dB( $\mu$ V) to 119 dB( $\mu$ V)
50 kHz to 150 kHz	113 dB( $\mu$ V) to 89 dB( $\mu$ V) Linear drop-off with logarithmically increasing frequency

The threshold values below 9 kHz are defined as percentage of the fundamental oscillation of the grid voltage. Thresholds from 9 kHz to 150 kHz are given as dB( $\mu$ V). For better comprehension, Figure 11 shows these values translated to voltage without logarithmic scale.

The graph shows, that the compatibility levels are decreasing very strong with increasing frequency, especially above 50 kHz. It can be seen that the example from Figure 9 with a level of 1.75 V at 10 kHz would fulfil the standard. The same level at a frequency of 50 kHz would mean a severe violation of the thresholds.



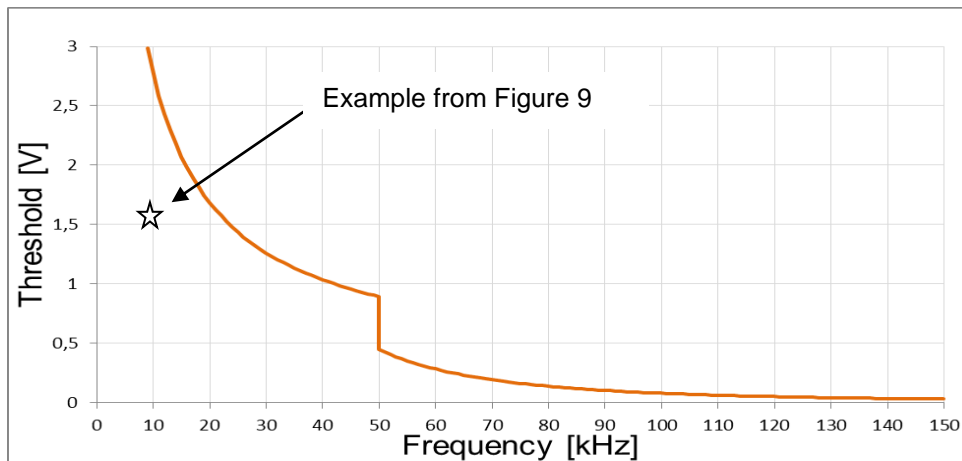

FIGURE 11: SUPRAHARMONIC THRESHOLDS OF IEC 61000-2-2 STANDARD

In the IEC61000-2-2 standard, intentional emissions, for example PLC signals for communication, are distinguished from nonintentional emissions.

Power utilities make use of a power line signal in the frequency range up to 148 kHz for signal transmission over the power grid. So that this signal can be detected unambiguously by the receiver, there must be a gap between the nonintentional emission from the power electronics, such as that caused by electric vehicles, and the PLC signal. Consequently, two limit curves are given in the standard.

There are many examples today of the mutual interference between different electronic devices. For example, the frequency converter of a CNC machine emits an interference level > 2.5 kHz into the power grid and a kitchen appliance malfunctions, or a solar inverter can automatically switch touch-dimmer lamps on and off.

### Measuring technology

Today, there are not many power quality measurement devices for permanent, uninterrupted monitoring of frequencies from DC to 150 kHz. This comes from the fact that there are no specifications as to how to evaluate in the future standard-compliant levels > 2.5 kHz to 150 kHz. The measuring procedure for the frequency range from 2 kHz to 9 kHz is described in the standard for harmonics, IEC 61000-4-7 in the informative Annex B. In this case, a grouping procedure for frequency bands of 200 Hz is used.

For the range > 9 kHz to 150 kHz, there is a suggestion in the Annex to IEC 61000-4-30, Ed. 3. Here, a grouping procedure for bands of 2 kHz is suggested. The final measuring procedure will only be specified in a few years in the future Edition 4 of IEC 61000-4-30. The frequency bands of 200 Hz or 2 kHz are under discussion. While a 200 Hz frequency band provides greater resolution in the spectrum, 10 times the quantity of data is measured than with a 2 kHz frequency band.

Because of this, each procedure has advantages and disadvantages. The PQ Box 300 from the manufacturer A.Eberle was used for the measurement campaign at the University of Applied Sciences Bingen. The power quality network analyzer measures frequencies from DC to 170 kHz with high accuracy. The grouping procedure of the measurement device can be configured for either 200 Hz or 2 kHz frequency bands. In this way, the different measurement results coming from the different grouping procedures can be verified.

### PROPAGATION OF SUPRAHARMONICS IN THE ELECTRICAL POWER GRID

Figure 12 clearly shows that the amplitude of the supraharmonics decreases with the distance from the electric vehicle to the transformer. These disturbance levels decrease more at higher frequencies than at lower frequencies. Hence the measurement at the transformer shows its maximum value at 8 kHz, while measurement at distribution level is dominated by 10 kHz values.

During the charging processes in this campaign, no violations of voltage supraharmonics according to IEC 61000-2-2 standard have been noticed.

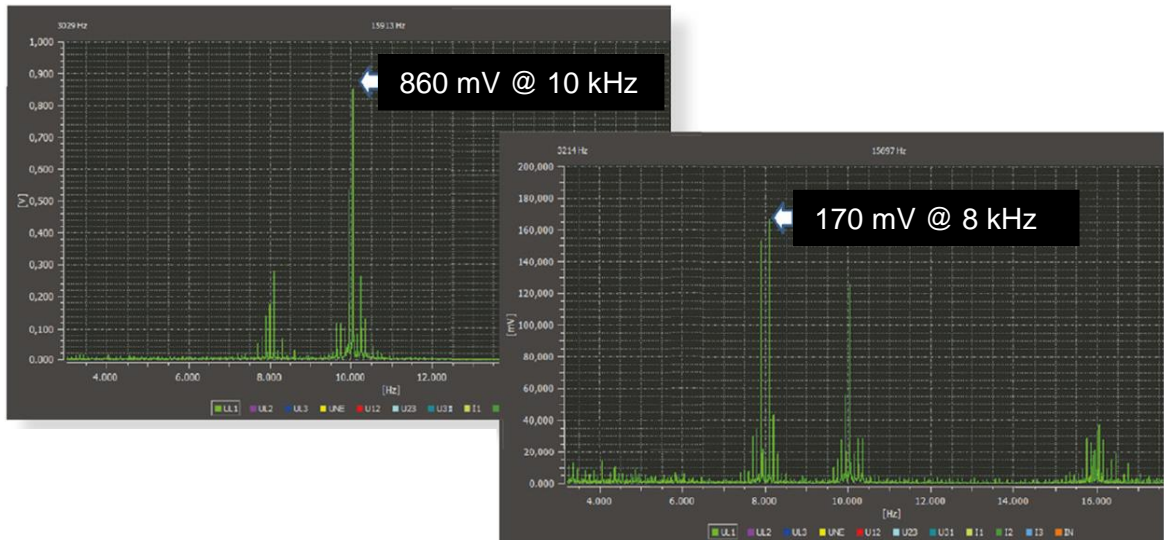

FIGURE 12: SIGNAL LEVEL OF SWITCHING FREQUENCIES AT SUB DISTRIBUTION MEASURING POINT 1100 (LEFT) AND DIRECTLY AT THE MAIN TRANSFORMER (RIGHT)

### MUTUAL INTERFERENCES BETWEEN ELECTRIC VEHICLES

During the measurement campaign, different electric vehicles were also charged in parallel to be able to evaluate the mutual interference between the vehicles.

**Connection configuration 1:** Electric vehicle No. 1 on the power grid alone

The vehicle is charged using one phase (L3). In the figure, you can see the voltages L1, L2, L3 and the charging current L3 for the electric vehicle. No pronounced loading effects can be seen on the current. The switching frequency of this vehicle was 50 kHz.

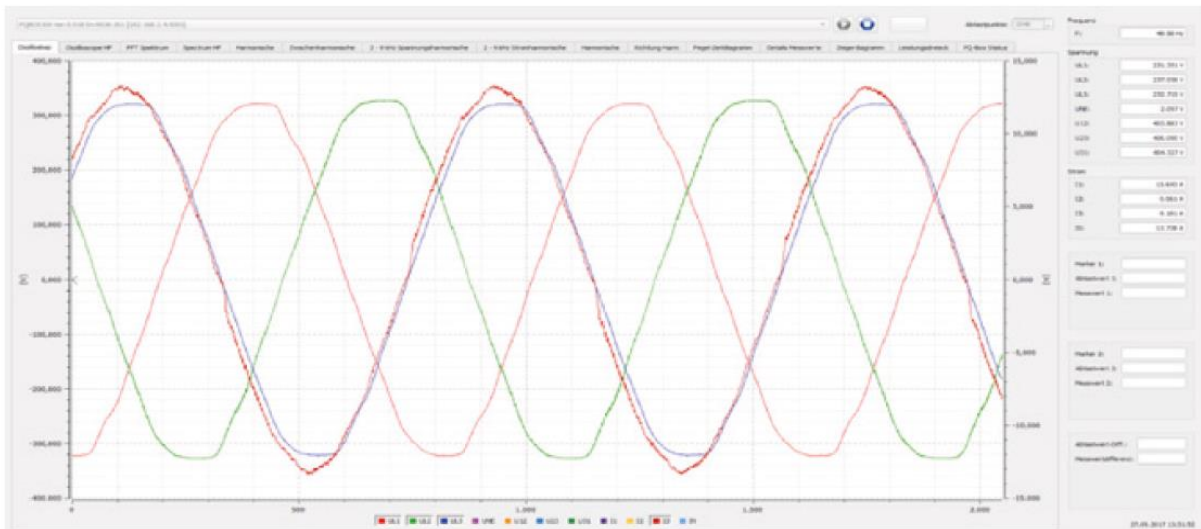

FIGURE 13: ELECTRIC VEHICLE NO 1 CONNECTED TO THE CHARGING STATION ALONE

**Connection configuration 2:** Electric vehicle No. 1 is connected to the station and electric vehicle No. 2 is connected in parallel using the type 2 plug.

The following Figure 14 shows a clear change in the current consumption of electric vehicle No. 1 due to the loading effects from electric vehicle No. 2.

The RMS value is virtually unchanged but there are large peaks in the charging current at the switching frequency of vehicle No. 2. Vehicle No. 1 is connected to the power grid acting as an interference sink for the



supraharmonics of the adjacent vehicle. In this example, a 10 kHz switching frequency can barely be seen in the voltage but is very pronounced in the current. There are reports from practical use that sporadic interruptions in charging may occur if various different electric vehicles are charged in parallel.

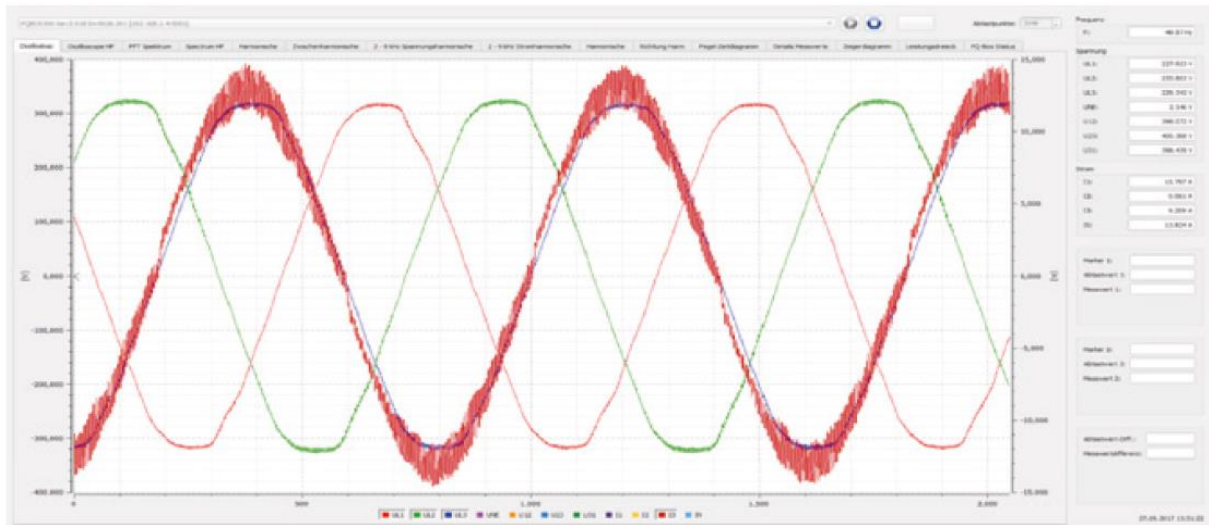

FIGURE 14: ELECTRIC VEHICLES NO. 1 AND NO. 2 ARE CONNECTED IN PARALLEL, STILL MEASURING AT VEHICLE NO. 1

### MUTUAL INTERFERENCES BETWEEN ELECTRIC VEHICLES AND SOLAR INVERTER

The following figure shows the initial power grid load with an inverter and a solar power plant. You can see the chopper frequency of 16 kHz and its harmonics at 32 kHz, 48 kHz, and so on.

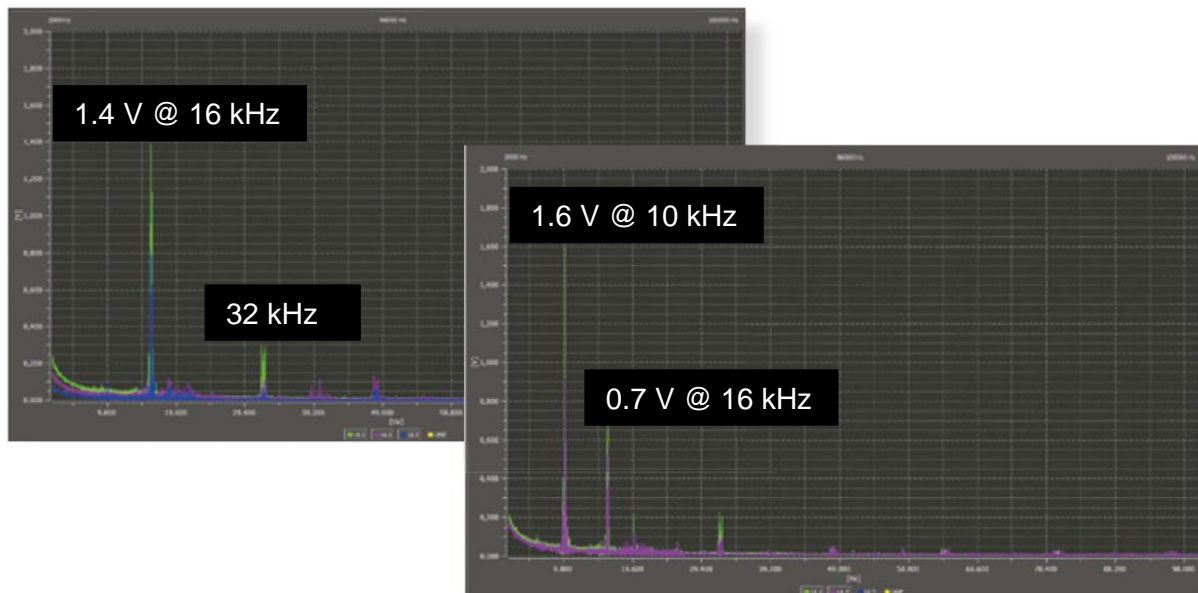

FIGURE 15: VOLTAGE LEVELS AT A PV POWER PLANT BEFORE (LEFT) AND AFTER THE CONNECTION OF AN ELECTRIC VEHICLE (RIGHT)

Now, an electric vehicle is connected to the charging station. You can now clearly see the 10 kHz switching frequency of the vehicle with 1.6 V in the power grid. The 16 kHz level of the solar inverter was reduced by 50% from 1.4 V to 0.7 V, because the input capacitor of the electric vehicle charger acts like a filter for the 16 kHz disturbances of the PV plant.

### TRANSIENT SWITCHING PEAKS

While starting the charging process, almost all examined EVs showed transient peaks in voltage and current (Figure 16). The largest voltage transient measured had a value of 400 V and was determined at a sampling frequency of 1 MHz. The highest inrush current peak had a value of 150 A.

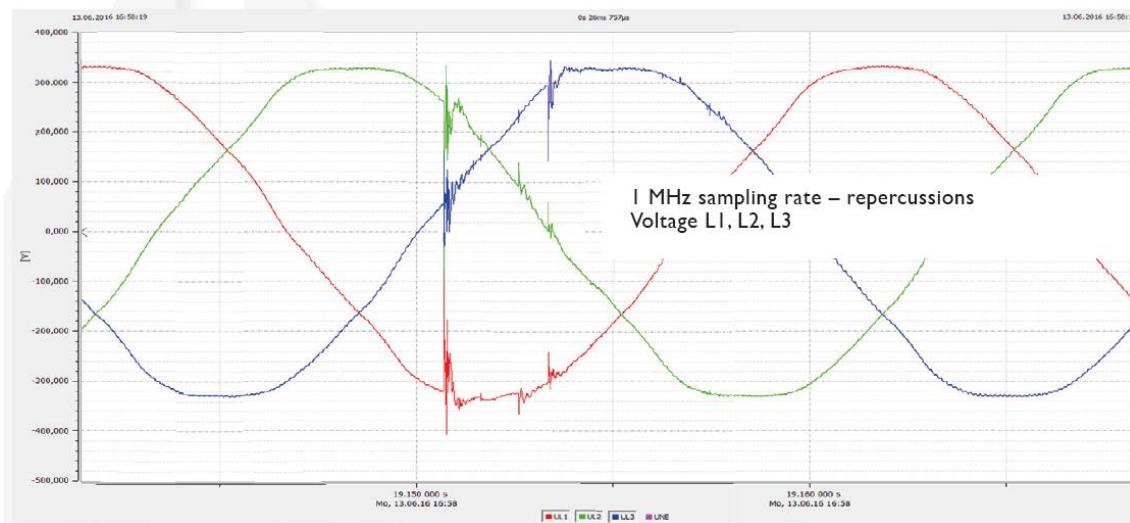

FIGURE 16: VOLTAGE TRANSIENTS AT ALL THREE PHASES

## SUMMARY

Some electric vehicles are charged single-phase with a power of significantly more than 4.6 kVA (during the measurement campaign with up to 7.2 kVA).

High-frequency disturbances are generated by the EVs in a very different range. However, all vehicles also act as disturbance sink and absorb these supraharmonics from the network. All vehicles generate a strong voltage transient at the moment of switching on the power. This could also disrupt other end-users.

Current harmonics of different EV manufacturers add up in the grid, but not as strongly as in a linear addition. All series manufactured vehicles did not violate the limit values of current harmonics up to the 50th order.

Electric vehicles and modern power electronics may generate loading effects on the power grid far above 2.5 kHz. The compatibility levels for these frequencies are defined in EMC standard IEC 61000-2-2. The measuring procedure for this is not been defined at this time. Most likely the 200 Hz Band calculation will be chosen. The PQ Box 300 from A. Eberle measures the range up to 170 kHz as a continuous measuring task.

The measurement device can be set to frequency bands of 200 Hz or 2 kHz. This feature makes it ready for future changes to the standards. In addition, it is possible to select a different measuring procedure than for the parallel online measurement for recording.

## REFERENCES

- [1] Plumhoff, 2013, Studie Power Quality in der Elektromobilität – Auswirkungen der Ladeinfrastruktur von Elektrofahrzeugen auf die Netzqualität, FH Bingen, 11 pages
- [2] VDN, 2007, Technische Regeln zur Beurteilung von Netzrückwirkungen. 2. Ausgabe, 13 pages
- [3] DIN EN 61000-3-2 (VDE 0838-2), 2015, Elektromagnetische Verträglichkeit (EMV) – Teil 3-2: Grenzwerte für Oberschwingungsströme (Geräte-Eingangstrom  $\leq 16$  A je Leiter), 41 pages
- [4] DIN EN 61000-3-12 (VDE 0838-12), 2012, Elektromagnetische Verträglichkeit (EMV) – Teil 3-12: Grenzwerte – Grenzwerte für Oberschwingungsströme, verursacht von Geräten und Einrichtungen mit einem Eingangsstrom  $> 16$  A und  $\leq 75$  A je Leiter, die zum Anschluss an öffentliche Niederspannungsnetze vorgesehen sind (IEC 61000-3-12:2011), 28 pages

[5] DIN EN 61000-2-2/A2, 2018, Elektromagnetische Verträglichkeit (EMV)–Teil 2-2: Umgebungsbedingungen –Verträglichkeitspegel für niederfrequente leitungsgeführte Störgrößen und Signalübertragung in öffentlichen Niederspannungs-Versorgungsnetzen, 29 pages